

THE ONE FOR ALL COLOURS OF LIFE



315

Hanse   
BREAKING RULES . SETTING TRENDS





# THE

# ONE

FOR ALL

# COLOURS OF LIFE

Die HANSE 315 bringt auf den Punkt, was eine exzellente Yacht ausmacht: die überragende Kombination aus angenehmem Komfort, faszinierender Performance und unvergleichlicher Individualisierbarkeit. Erleben Sie selbst, wie sich auch große Ansprüche perfekt kompakt umsetzen lassen. In Ihrer persönlichen HANSE 315.

---

The HANSE 315 unites everything that makes a yacht excellent: an outstanding combination of comfortable convenience, thrilling performance and unparalleled customisation options. Experience for yourself how even your highest standards are made reality in a perfectly compact yacht: your personal HANSE 315.





Gebaut, um auf See zu begeistern. Die markanten schnellen Rumpflinien, das hohe Rigg und der perfekt abgestimmte Segelplan stammen aus der Feder von judel/vrolijk & co, den besten und erfahrensten Yacht- Konstrukteuren der Welt. Das Zusammenspiel aus revierangepasstem Lateralplan und vorbalanciertem Ruderblatt ist ein Garant für überragende Schnelligkeit, Stabilität und Sicherheit.

Built to amaze at sea. The distinct hull lines underscoring speed, the high rig and the optimised sailing plan all stem from the feather of judel/vrolijk & co, the world's best and most experienced yacht construction engineers.. The interplay of a perfectly adapted lateral plan and a pre-balanced rudder blade is your guarantee for fantastic speed, stability and safety.

# FAST

# CRUISING



Feel the pleasure of

COMFORT & SPEED

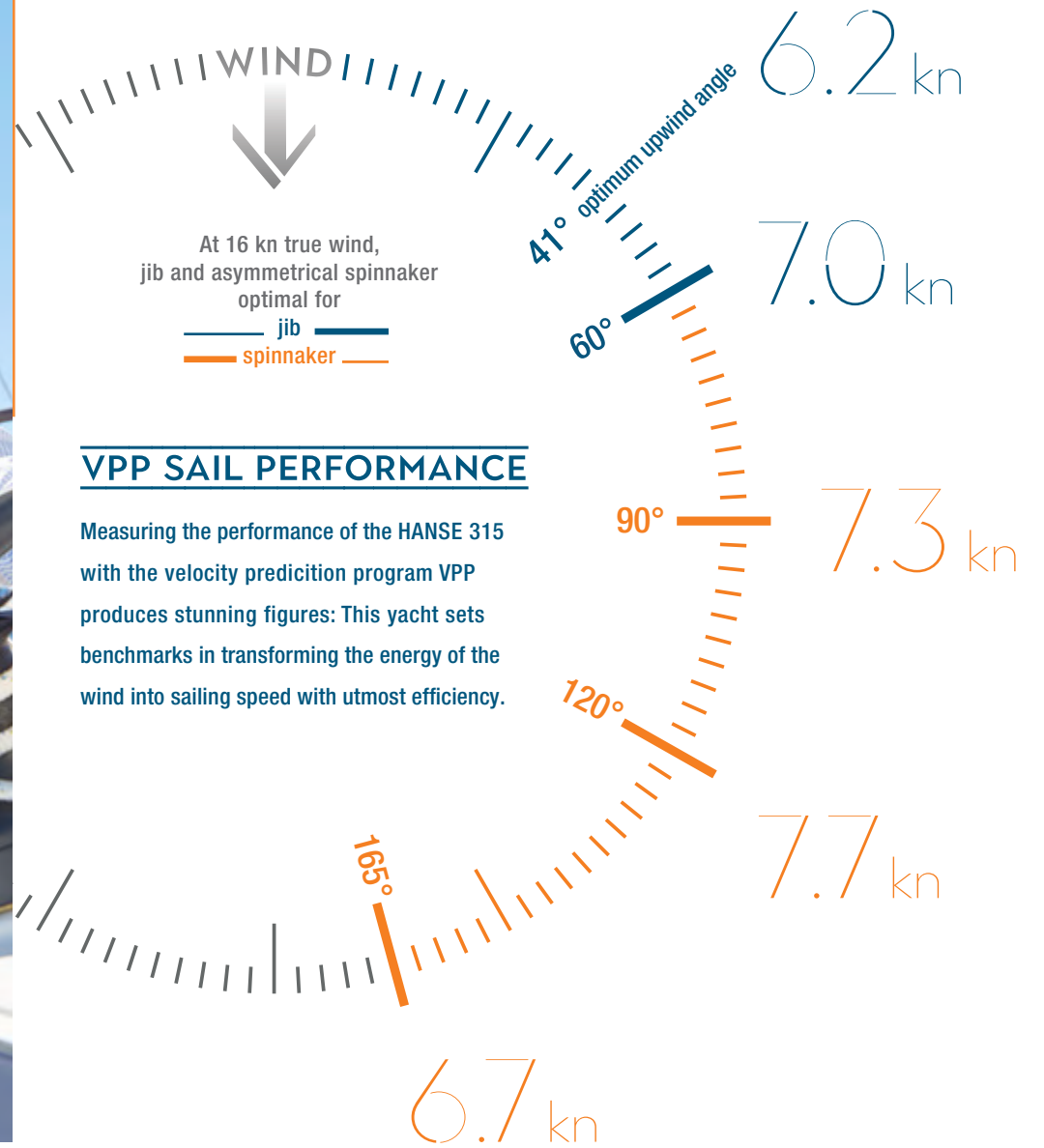

### VPP SAIL PERFORMANCE

Measuring the performance of the HANSE 315 with the velocity prediction program VPP produces stunning figures: This yacht sets benchmarks in transforming the energy of the wind into sailing speed with utmost efficiency.

FAST CRUISING

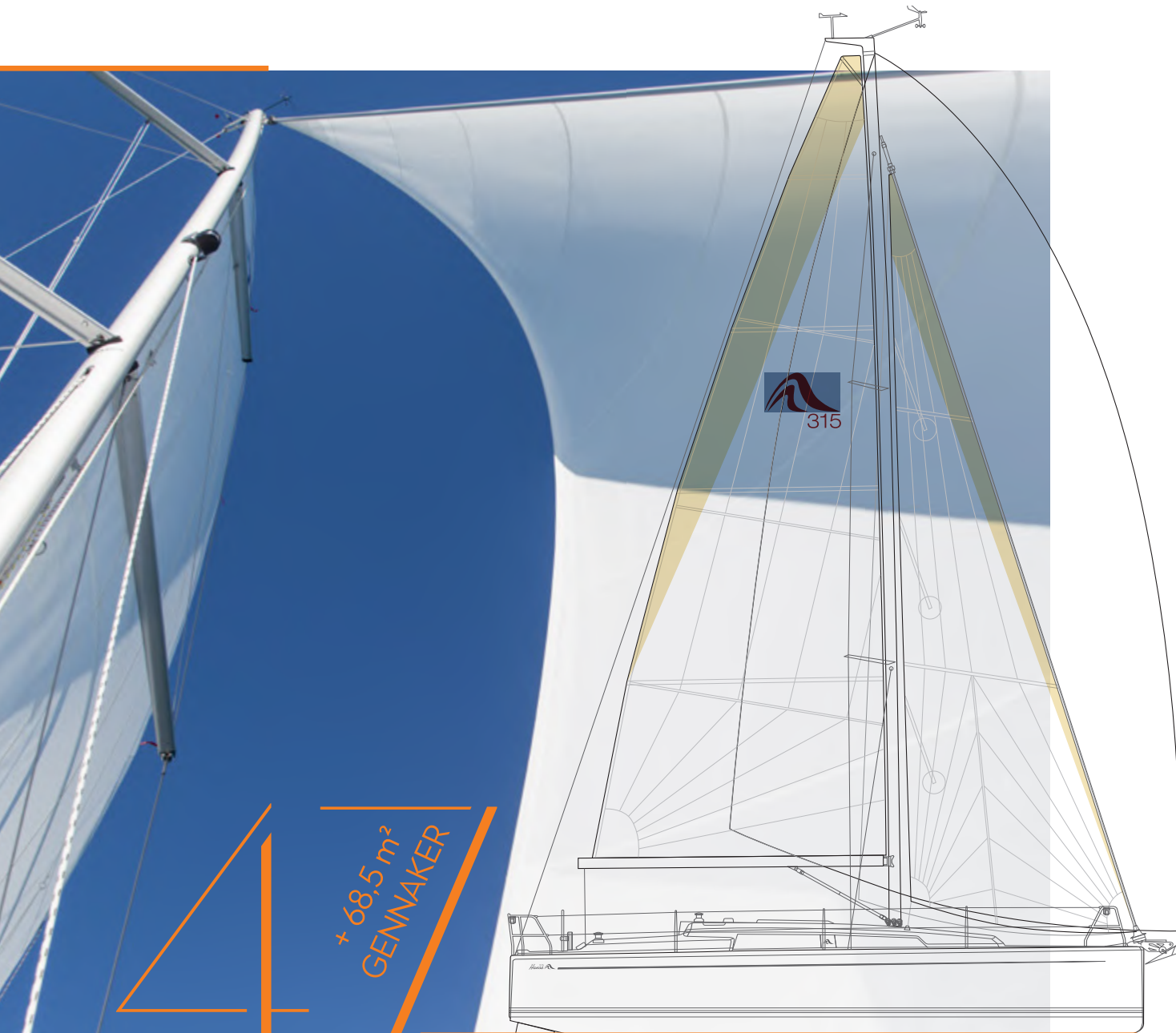

+ 68,5 m<sup>2</sup>  
GENNAKER

m<sup>2</sup> TOTAL SAIL AREA

## RIG & SAIL OPTIMISATION

Ein hohes Rigg ist das Markenzeichen von HANSE. Die Yacht designer von judel/vrolijk & co passen den Segelplan mit hochentwickelten Berechnungsmodellen perfekt an jede HANSE an. Das garantiert beste Segeleigenschaften bei allen Bedingungen und macht eine HANSE zu der schnellsten Yacht in ihrer Klasse.

A high rig is the trademark of every HANSE. The yacht designers from judel/vrolijk & co perfectly form the sail plan for each HANSE with the use of highly sophisticated calculation models. This guarantees that you have the best sailing characteristics under all conditions, and it ensures your HANSE is one of the fastest yachts in its class.





Hanse

0° heeling angle

15° heeling angle

## CONSTANTLY LONG WATERLINE

Voraussetzungen für eine herausragende Performance sind das steile Heck und der gerade Steven. Dieses intelligente Design ermöglicht eine optimal lange Wasserlinie bei jedem Krängungswinkel – und damit eine überlegene Geschwindigkeit auf allen Kursen.

Outstanding performance comes from having a steep stern and a straight stem. This intelligent design provides an optimal, long waterline at any heeling angle – and superior speed for you on all courses.

**FAST CRUISING**



LOA  
9.6 m

BEAM  
3.35 m

DRAFT  
1.85 m

DIAPLACEMENT  
5.3 t



## HANSE SMART TRIM SYSTEM

Wir trimmen die Segel wie die Profis und setzen auf ein Achterstag, das sich stufenlos verstellen lässt. Damit können Mastbiegung und Profiltiefe der Segel jederzeit dem Wind angepasst werden.

We have trimmed the sails so you can sail like a pro and included a backstay, which can be adjusted seamlessly. This enables the mast and the profile of the sail to perfectly adapt to the wind at all times.



FAST CRUISING



Das HANSE Easy-Sailing-Concept ist legendär. Wir haben die integrierte Selbstwendefock konzipiert und sämtliche Leinen zum Doppel-Steuerstand umgelenkt, so dass Sie diese Yacht völlig entspannt auch ganz alleine segeln können. Manöver wie Reffen, Wenden und Segelsetzen erledigen Sie über zwei Winschen bequem und schnell von Ihrem Steuerstand aus. Das Deck ist kompromisslos frei von Leinen und Beschlügen. Damit genießen Sie freie Sicht und haben im Hafen viel Platz zum Entspannen. So geht Segeln heute!

---

The HANSE Easy Sailing concept is legendary. We are the designers of the integrated self-tacking jib, with all the ropes guided directly to the two-wheel helm, enabling you to sail this yacht with the greatest of ease all on your own. Manoeuvres like reefing, tacking and setting the sails can all be done comfortably and quickly using just two winches at the helm. The deck is completely free of all ropes and fittings – so you can enjoy an uncompromising view and have lots of space for relaxing. Modern sailing at its best!

# EASY SAILING

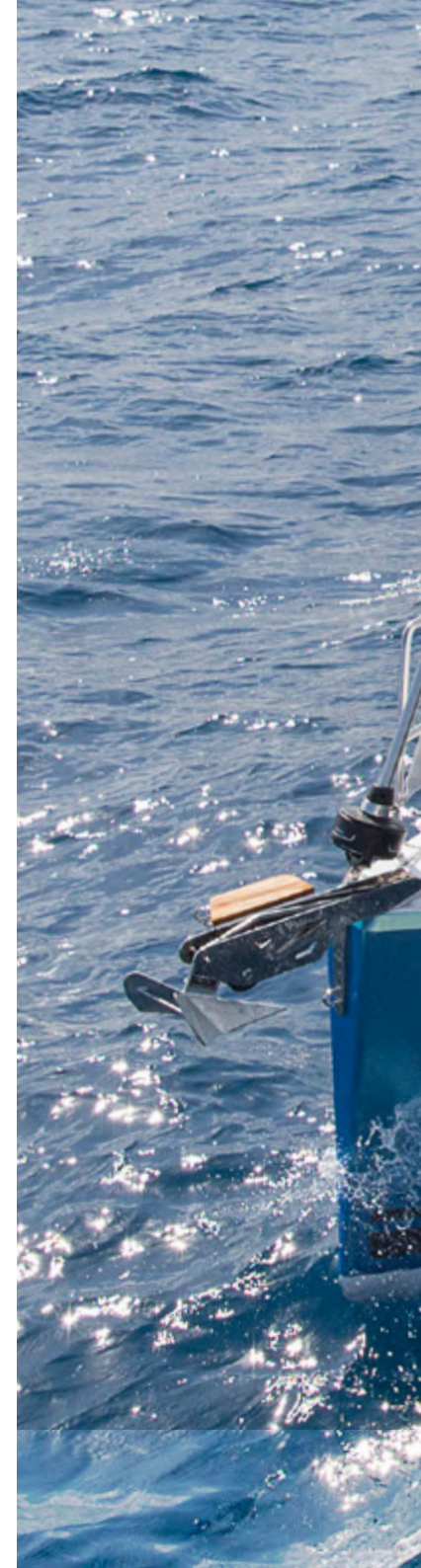



## HANSE SELF-TACKING JIB

Die Selbstwendefock ermöglicht einfache und schnelle Manöver. In der Wende oder Halse gleitet das Vorsegel über die integrierte Decksschiene von selbst auf die richtige Seite.

The self-tacking jib lets you manoeuvre the yacht easily and quickly. In the tack or the jib, the headsail smoothly glides over the integrated deck rails automatically to the correct side.



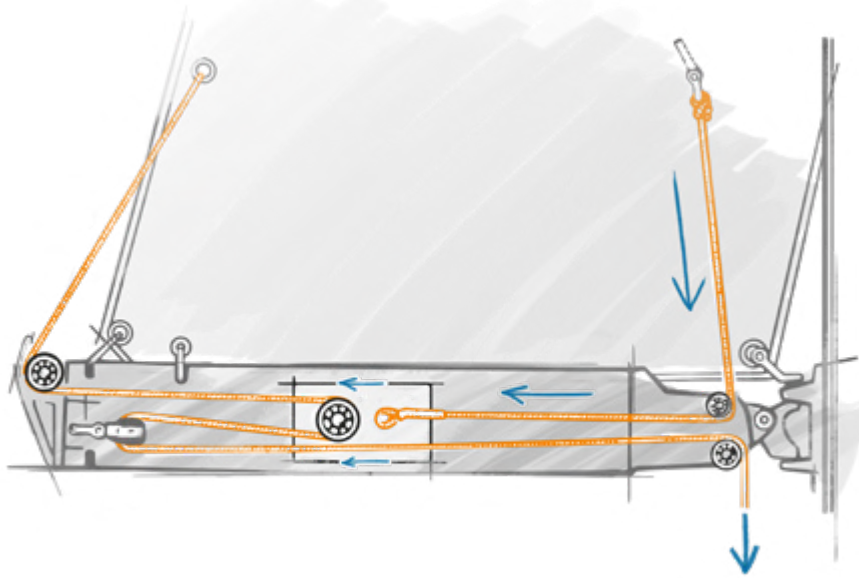

## HANSE ONE-ROPE REEF SYSTEM

Sie bestimmen die Größe der Segelfläche – und das ganz bequem vom Cockpit aus. Das HANSE Einleinen-Reffsystem ermöglicht einfaches und schnelles Handling.

You decide the size of the sail area – easily from the comfort of the cockpit. The HANSE One-Rope Reef System ensures that handling is quick and effortless for you.



EASY SAILING

## HANSE RUDDER BALANCE

Beim Design der Ruderanlagen setzt HANSE kompromisslos auf Sicherheit – bei gleichzeitiger Agilität. Deshalb haben wir ein vorbalanciertes Ruder entwickelt, dessen wirksame Oberfläche überdurchschnittlich groß ist. Damit lässt sich die Yacht in jeder Situation spielend leicht steuern.

When it comes to the design of the rudder system, HANSE gives you high agility without compromising safety. For this, we have developed a pre-balanced rudder whose efficient surface is larger than average. It makes steering the yacht in any situation child's play.

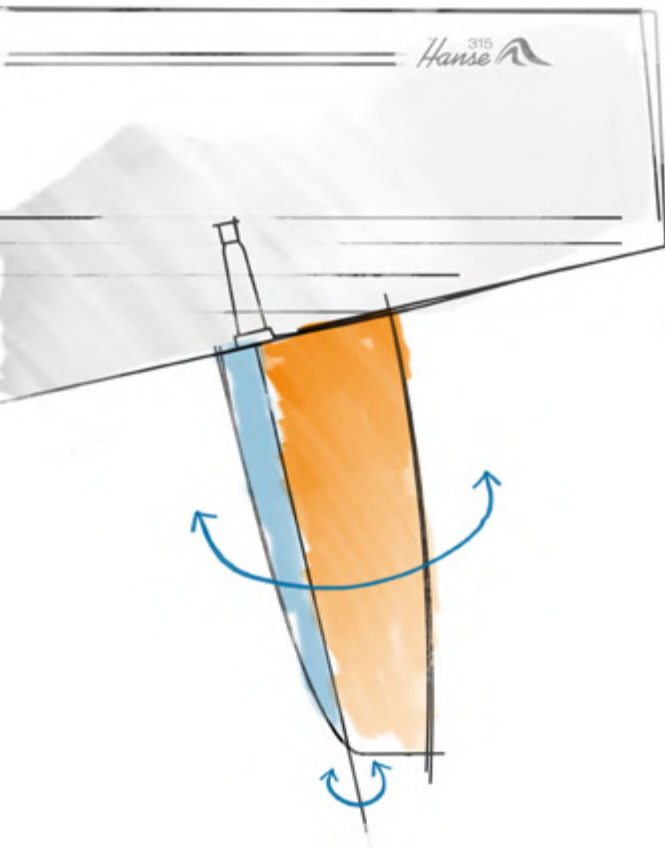



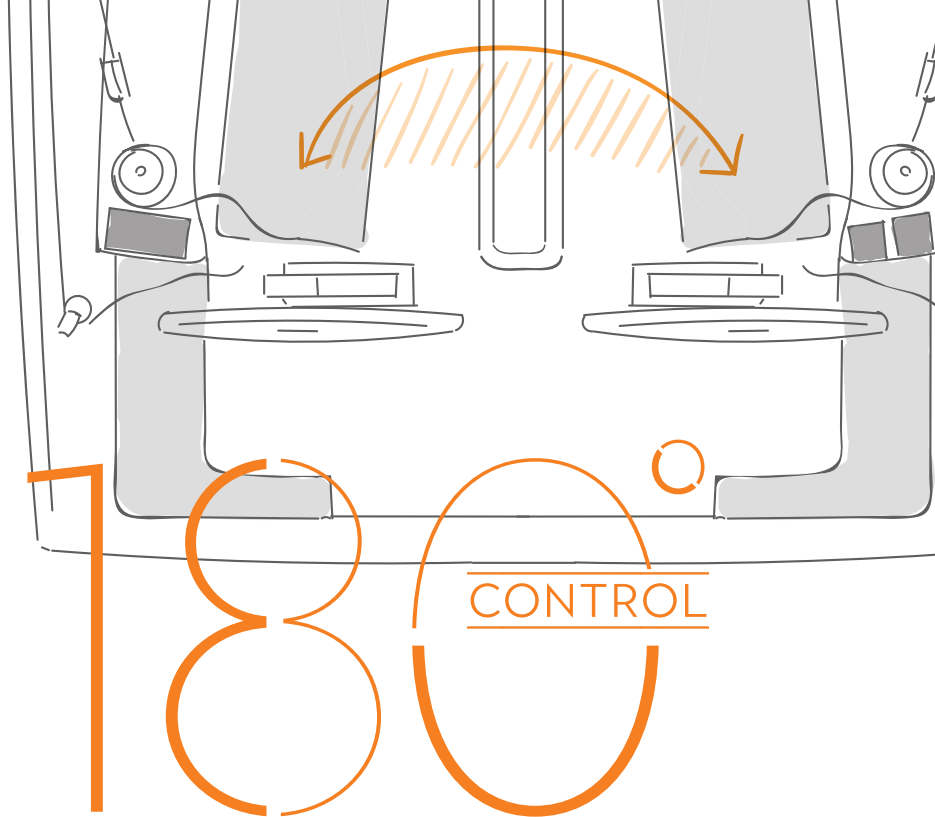

## HANSE HELSMAN CONTROL

Alles im Blick. Alles im Griff. Auf einer HANSE steuern Sie die gesamte Technik bequem und übersichtlich vom Cockpit aus. Alle Schoten führen zum Steuerstand, somit haben Sie die absolute Kontrolle in allen Segelmanövern.

Everything at a glance. Everything under control. On a HANSE the entire system can be steered from the cockpit. All the halyards lead to the helmsman. This gives you absolute control in all sailing manoeuvres.



EASY SAILING





In allem einen Schritt voraus. Technische Innovationen und Detailqualität sind ebenso ein Teil von HANSE wie emotionale Formensprache und Wohlfühlatmosphäre. Dabei setzt jedes Detail ein klares Design-Statement. Das perfekte Zusammenspiel von fortschrittlicher Technologie und ihrer Umsetzung im Design ist unser Anspruch an die perfekte Yacht.

---

With HANSE, you have a progressive yacht that makes a statement. Technical innovations and quality in every detail are just as much part of the HANSE 315 as are an emotional design and comfortable atmosphere of wellbeing. Each detail is a subtle expression of superior design. The well-orchestrated ensemble of advanced technology and its integration is the highest art of yacht design at HANSE – and what drives us to create the perfect yacht.



# INNOVATIVE DESIGN

# HIGHLIGHTS

## EXTERIOR



Der schönste Platz unter freiem Himmel: Die HANSE 315 erfüllt Ihren Anspruch nach leichtem, sicherem und komfortablem Segeln. Mit der modernen Doppelsteuer-Anlage genießen Sie immer freie Sicht und haben alle wichtigen Instrumente stets im Blick. Vor Anker oder im Hafen genügt ein Handgriff und die Badeplattform erweitert das geräumige Cockpit und bietet den direkten Zugang zum Meer.

A great place under the blue skies: The HANSE 315 meets your every demand for easy, safe and comfortable sailing. Thanks to the two-wheel system, you can enjoy a clear view at all times and have the most important instruments continually in sight. At anchor or in the harbour, a single movement of the hand is all that is needed to extend the bathing platform and create a spacious cockpit, offering direct access to the water.

INNOVATIVE DESIGN



JOY OF LIFE

Greifswald



Erfüllt alle Wünsche: **1** Sportliche Doppelsteuer-Anlage oder **2** form-schöne Pinne? Die HANSE 315 bietet größtmögliche Flexibilität und lässt Ihnen die Wahl, eine Entscheidung ganz nach Ihrer persönlichen Vorliebe zu treffen. Im Zusammenspiel mit der integrierten HANSE Selbstwendefock und den sämtlich umgeleiteten Fallen und Schoten genießen Sie herrliches Easy Sailing und sehen dabei dank der markanten Sheerline auch noch fantastisch aus.

Makes all your wishes come true: **1** Do you prefer a sporty two-wheel helm or a **2** beautifully formed tiller? The HANSE 315 offers the greatest amount of flexibility and lets you decide which options you want to meet your personal preferences. The integrated HANSE self-tacking jib, with all the halyards and sheets guided out of the way to provide a clear space, means you can revel in Easy Sailing. Thanks to the striking sheerline, you will look fantastic at the same time.



# FOR ALL COURSES

INNOVATIVE DESIGN







# INNOVATIVE INTERIOR DESIGN

Das Interieur löst ein, was das Exterieur verspricht: Größe, Schönheit und Komfort, vereint zu einem Wohlfühlambiente der Extraklasse. Handgearbeitete Möbelstücke treffen auf hochwertige Materialien und ergeben eine Luxus-Yacht mit nautischen Charakterzügen.

The beauty of the interior perfectly reflects the exterior: generous, eye-catching and comfortable – all united to provide a first-class ambience of well-being. Handcrafted furniture meets high-quality materials to create a luxury yacht with the finest nautical characteristics.



Individuell und flexibel ausgebaut, wie Sie es möchten: **1** Nutzen Sie das Vorschiff zur idealen Verlängerung des Salons. Oder gönnen Sie sich Platz zur Entspannung. Im Handumdrehen lässt sich der Sitzplatz herunterklappen und wird Teil einer wunderbar bequemen Liegefläche. **2** Sie benötigen eine Einzelkoje? Dann freuen Sie sich über eine Kabine mit viel Raum für herrliche Erholung. **3** Und auch als Doppelkoje bietet das Vorschiff einen gemütlichen, persönlichen Rückzugsort für zwei.

Constructed to be unique and flexible, as you like: **1** Use the bow area as the ideal extension of the saloon. Or enjoy the space as an oasis of relaxation. At a flick of the wrist, the seat folds down to create a wonderfully comfortable lounge area. **2** Would you like to have your own cabin? Then look forward to a space with lots of room for peaceful relaxation. **3** Outfitted with a double cabin, the bow can also serve as a cosy, personal retreat for two.



# IDEAS

OPEN TO



Ob offenes oder geschlossenes Vorschiff, Sie verfügen über einen Raum, der sich stets perfekt an Ihre Bedürfnisse anpassen lässt: Relaxen auf der gemütlichen Doppelkoje. Oder im Sitz entspannt ein Buch lesen. Ihre Kinder brauchen Platz zum Toben? Dann heißt es, Sitzlehne wieder herunterklappen und es kann losgehen. Das Vorschiff der 315 macht einfach alles mit.



Whether with an open or closed bow, the HANSE 315 gives you space that continually adapts to your needs perfectly. Relax in the cosy double cabin. Or sit and enjoy a good book. Do your children need space for playing? Then simply fold down the back of the seat and voilà – its playtime. The bow on the HANSE 315 is ready for everything.

Modernes Ambiente: 1 Egal ob edles Chestnut, maritimes Mahogany oder modernes Oak: das Zusammenspiel aus hochwertigen Armaturen und viel Tageslicht machen jeden Aufenthalt im Badezimmer zum Vergnügen. 2 Der funktionale Kartentisch ist optisch perfekt integriert und dank seiner Platzierung neben dem Sofa vielseitig nutzbar.

Modern ambience: 1 Whether you choose elegant chestnut, maritime mahogany or contemporary oak: the interaction of the high-quality fittings and the host of sunlight make each moment in the bathroom a pleasure. 2 The functional charting table is integrated in such a way as to provide a visually harmonious appearance, and thanks to its positioning next to the sofa, it can be used in many ways.



## CABINS & DETAILS



MAHOGANY STYLE SATIN VARNISH

Optimal durchdacht: **1** In der voll ausgestatteten Pantry lassen sich mit kurzen Wegen die leckersten Gerichte zaubern. **2** Wer Entspannung sucht, findet sie unter Deck auf dem gemütlichen Sofa. Die Rumpfenster lassen viel Licht herein und am Abend schafft die zum Lesen platzierte Lampe die besten Voraussetzungen für gemütliche Stunden.

Optimally designed: **1** In the fully equipped galley, delicious meals can be conjured up quickly with little effort. **2** If you are looking to relax, a cosy sofa awaits you below deck. The hull windows let in lots of sunlight. In the evening, the lamp, which has been ideally positioned for reading, creates the best atmosphere for memorable moments.



CHOOSE  
ONE  
ABSLOUTLY UNIQUE YACHT

Wohin Sie auch segeln – Ihre HANSE ist ein Unikat. Wählen Sie die Farbe des Rumpfes und auf welchen Polstern Sie Ihren Sundowner genießen. An Deck bestimmen Sie über die technische Ausstattung Ihrer HANSE-Yacht. Auch das Interieur trägt Ihre Handschrift. Genießen Sie die Freiheit auf See in einem coolen Loft oder umgeben von maritimer Eleganz. Wählen Sie einfach die für Sie perfekten Materialien und exklusiven Ausstattungen aus! Im HANSE Online-Konfigurator auf [hanseyachts.de](http://hanseyachts.de) können Sie Ihre HANSE nach Ihren Vorstellungen konfigurieren und auf Wunsch direkt ein Angebot anfordern.

Wherever you sail – your HANSE is one of a kind. Select the colour of the hull, and of the upholstery on which you want to enjoy your cocktails. On deck, you choose how you want to technically outfit your HANSE yacht. You can likewise make your mark on the interior. Enjoy freedom at sea in a cool loft-like atmosphere or surrounded by maritime elegance. Simply choose the perfect materials and furnishings for you! With the HANSE Online Configurator at [hanseyachts.com](http://hanseyachts.com), you can pre-configure your HANSE to your individual taste and request an offer directly if you like.



# INDIVIDUAL

CUSTOMIZATION

 315



Segeln Sie am liebsten zu zweit, mit der Familie oder im großen Freundeskreis? Die Raumaufteilung Ihrer HANSE 315 lässt sich individuell Ihren Wünschen anpassen. Sie haben die Wahl zwischen dem klassischen Standardlayout oder einem flexiblem Kabinen-Konzept für mehr oder weniger Gäste an Bord.

---

Do you like to sail with your most loved one, with family or a large group of friends? The layout of your HANSE 315 can be adapted to suit your personal wishes. You can choose between the traditional standard layout and a flexible cabin concept for more or fewer guests on board.

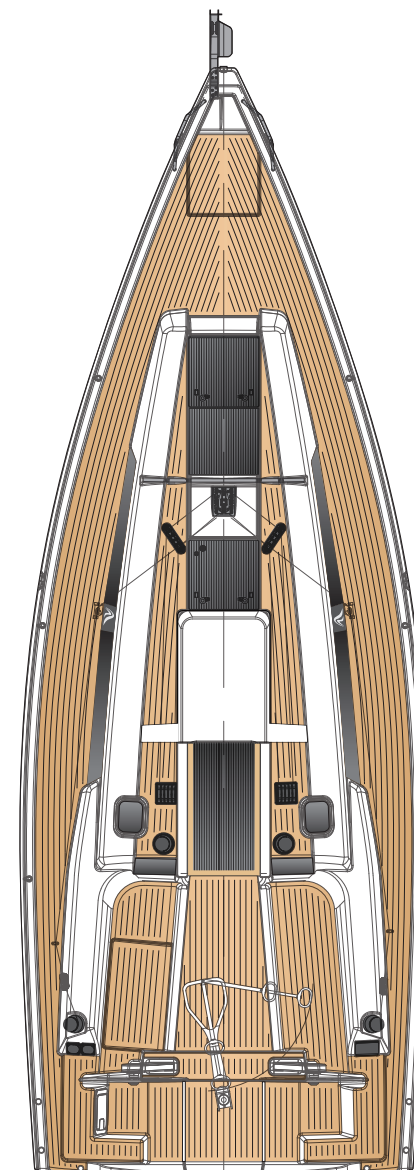

CABIN  
INDIVIDUAL CONCEPT



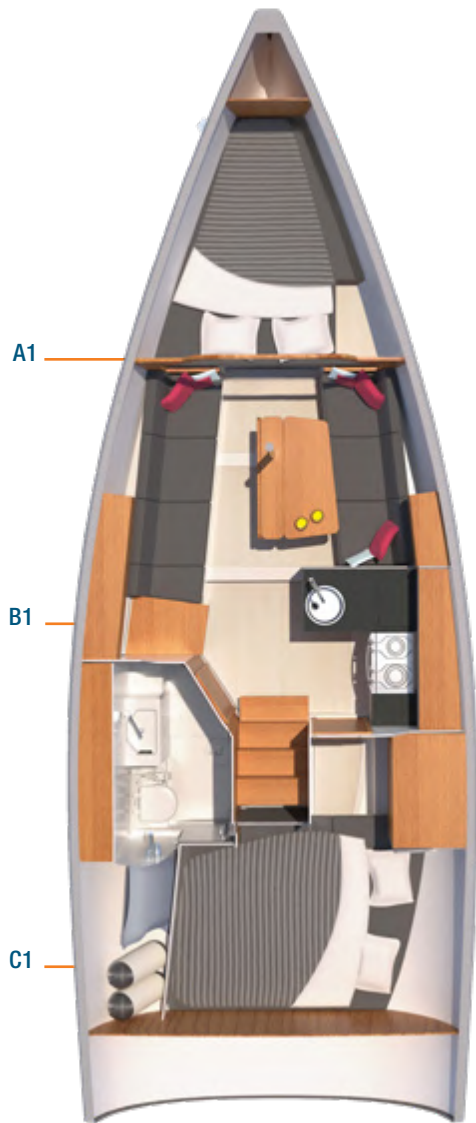

**Standard**

Family cabin with open bulkhead  
Huge double-berth

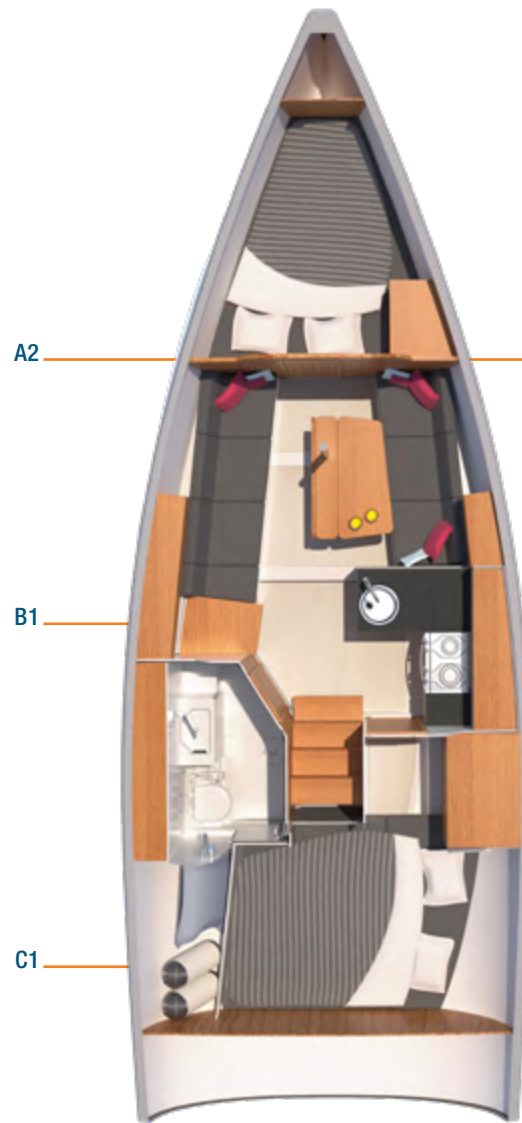

**Option**

Family cabin  
Huge double-berth cabin



**Option**

Family cabin  
with Children's space



**Option**

Family cabin  
Complete single-berth cabin



# TEAK DECK

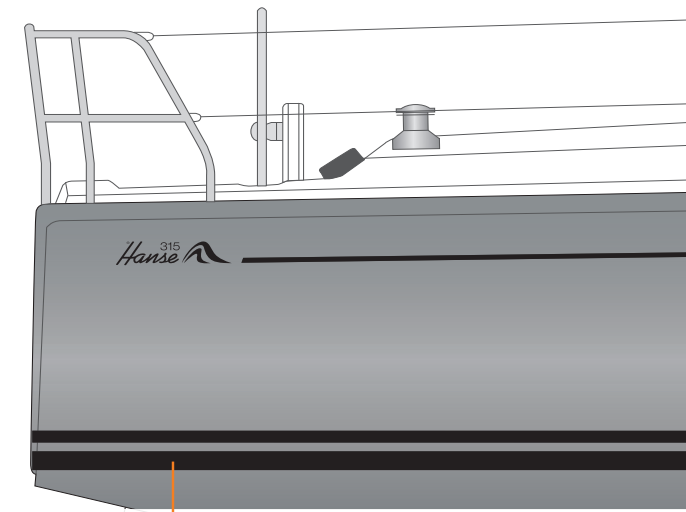

Black  
RAL 9011  
Option

## TEAK & SYNTHETIC TEAK

Options: **1** Teak · Synthetic Teak: **2** Teak Black  
**3** Teak Grey **4** Teak White **5** Scrubbed Black  
**6** Scrubbed Grey **7** Scrubbed White **8** Weathered Black **9** Weathered White

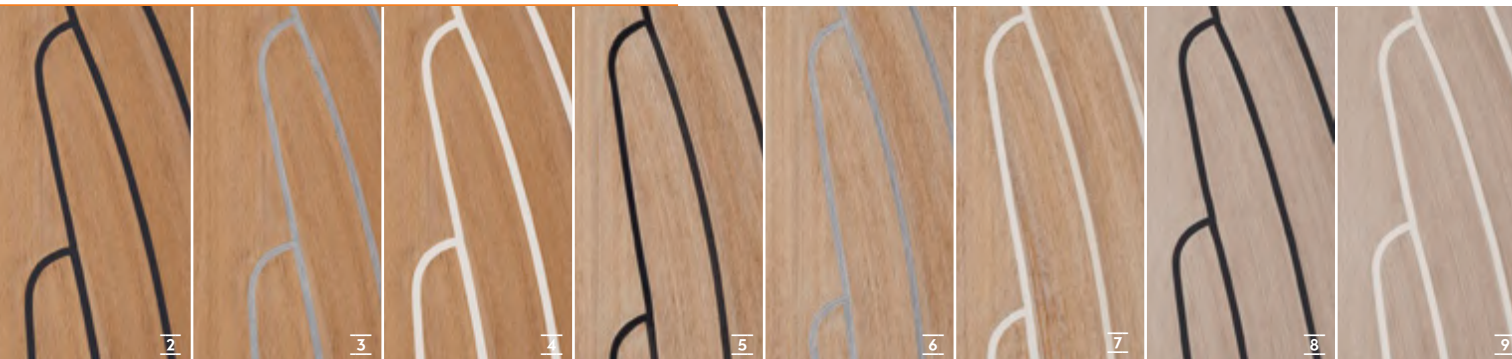

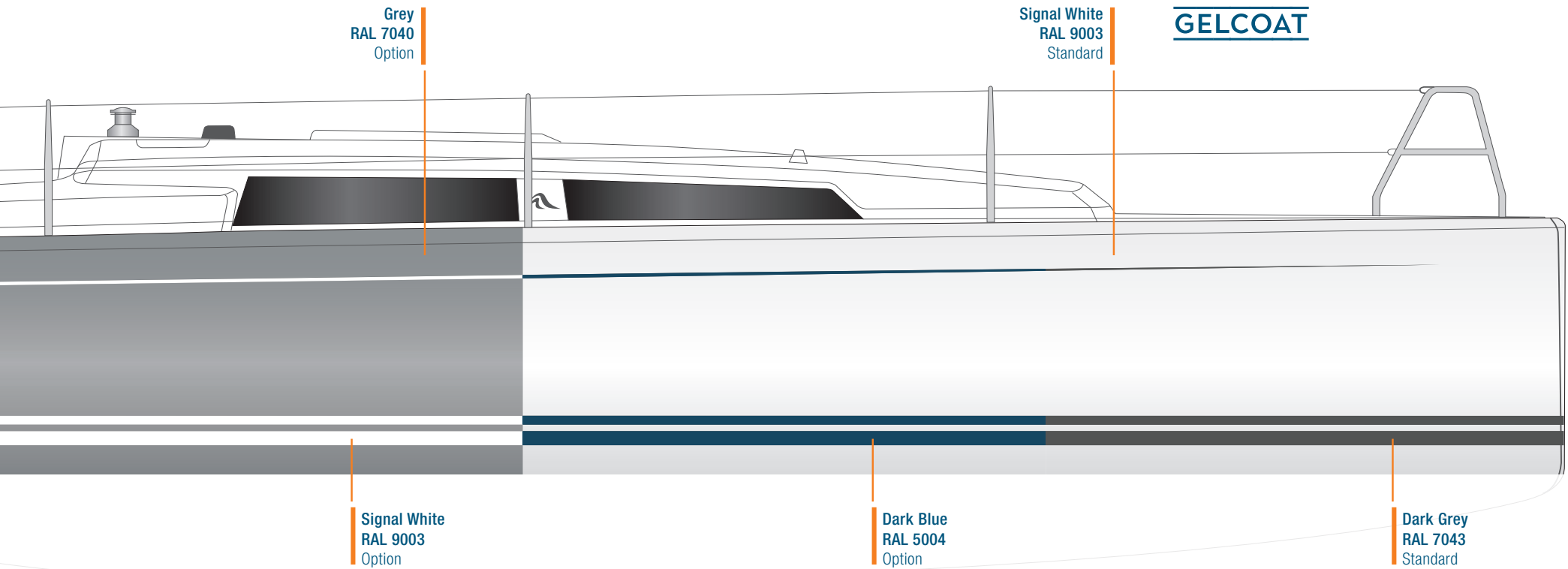

GELCOAT

Grey  
RAL 7040  
Option

Signal White  
RAL 9003  
Standard

Signal White  
RAL 9003  
Option

Dark Blue  
RAL 5004  
Option

Dark Grey  
RAL 7043  
Standard

Gelcoat Rumpf- oder Wasserpass-  
farben. Bei HANSE können Sie Farbe  
bekennen, aus einer Vielfalt an Mög-  
lichkeiten.

Gelcoat hull and waterline colours.  
At HANSE, you can select your favourite  
colour for your new yacht.

# COLOURS

HULL & WATERLINE

MATERIALS EXTERIOR

# STYLE

CREATE  
YOUR OWN  
LIFE

Eine individuelle Yacht für eine einzigartige Persönlichkeit. Wer eine HANSE segelt, will das Besondere. HANSE bietet Ihnen die Möglichkeit, dieses Besondere ganz persönlich zu gestalten. Ihrer Fantasie sind kaum Grenzen gesetzt. Unsere Experten helfen Ihnen gerne bei der Auswahl.

Your own individual yacht for your unique personality. Discerning connoisseurs sail HANSE, as we offer you the chance to express your style personally. There are no limits to how creative you can be. Our experts are happy to support you in choosing the perfect accents.



## LAZY BAG . BIMINI . SPRAYHOOD . COVER

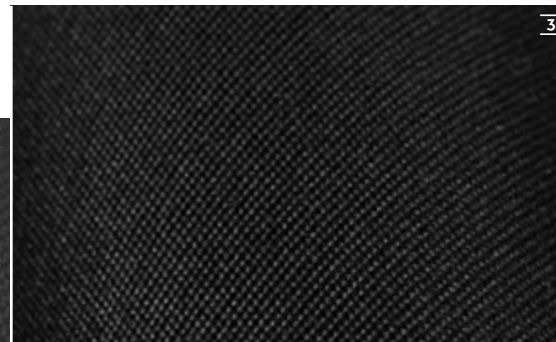
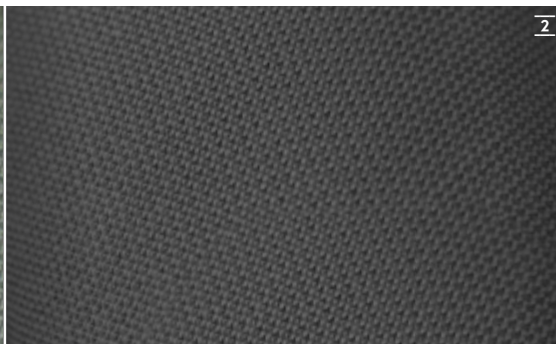

Options: [1](#) Light Grey [2](#) Dark Grey [3](#) Black [4](#) Cream

## CUSHIONS FOR COCKPIT

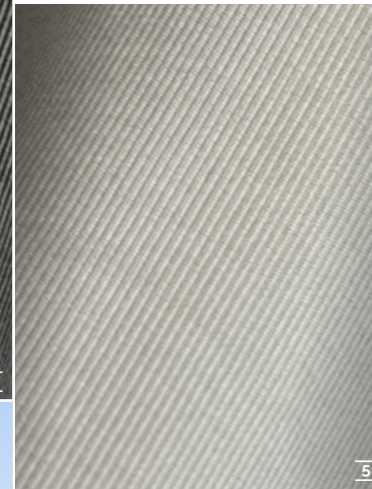
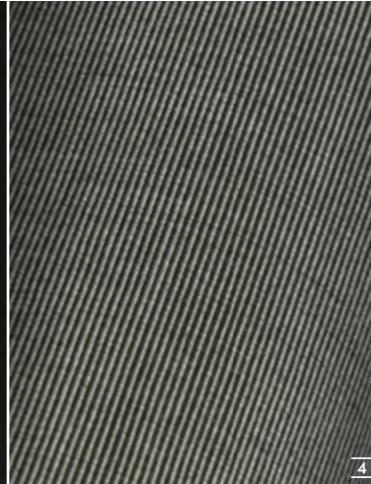
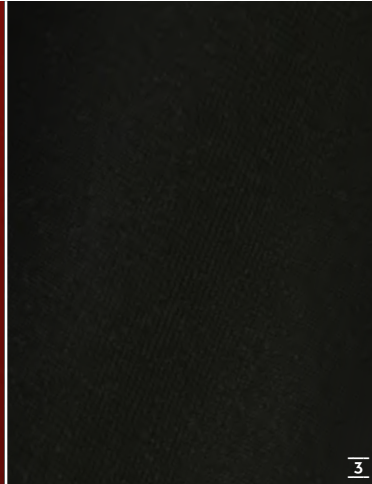

Options:

[1](#) Dark Blue [2](#) Red [3](#) Black [4](#) Dark Grey [5](#) Light Grey [6](#) Cream

**FABRICS EXTERIOR**

## FLOORBOARDS

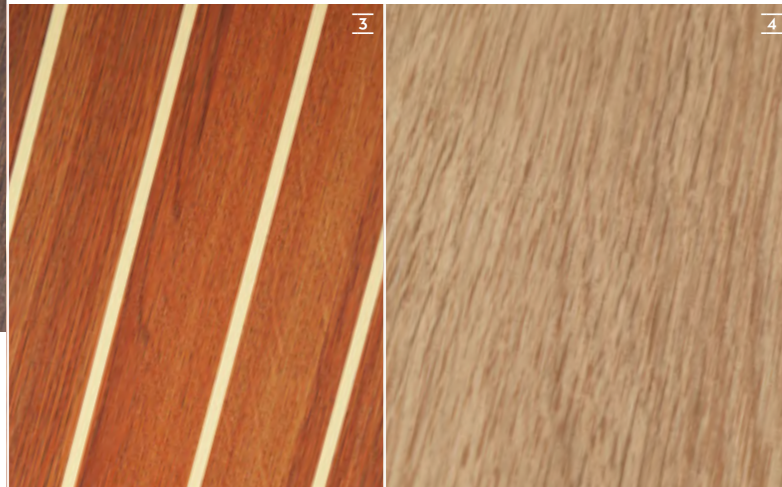
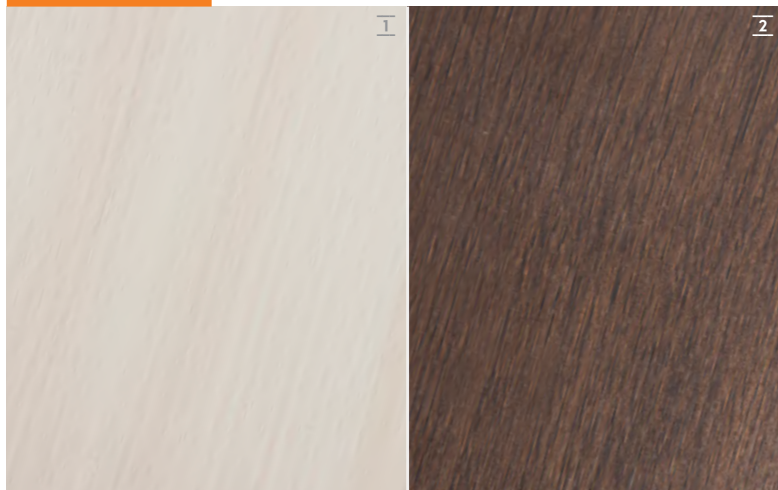

Standard: 1 Acacia - Options: 2 Noce Nero 3 Classic Stripes 4 Delight Oak

## FURNITURE

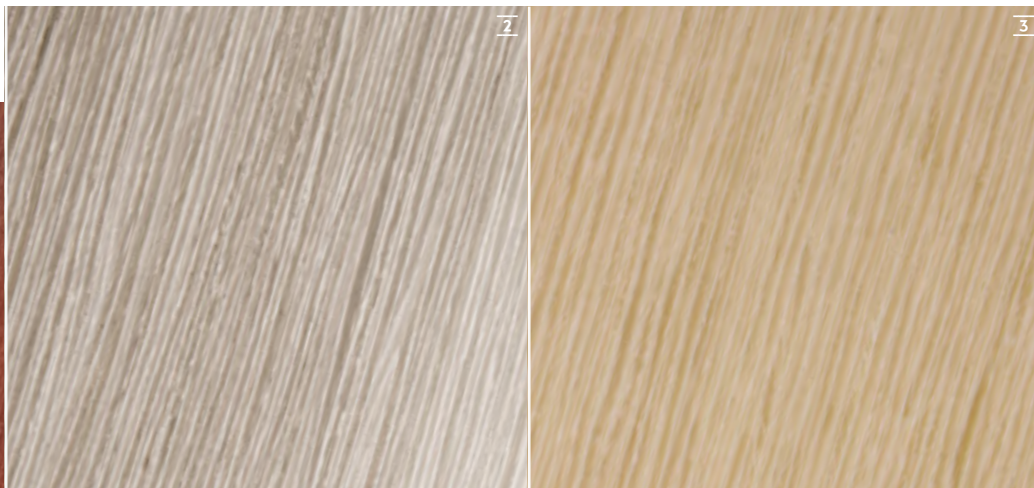
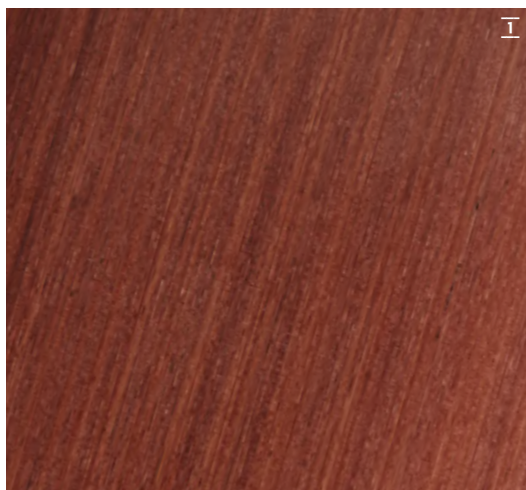

Standard: 1 Mahogany Style Satin Varnish - Options: 2 Canadian Chestnut Satin Varnish 3 French Oak





## WORKTOP GALLEY

Standard: 1 Black Quartz - Option: 2 Seashell White

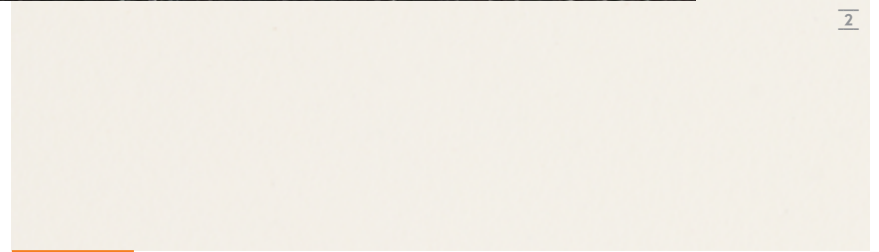
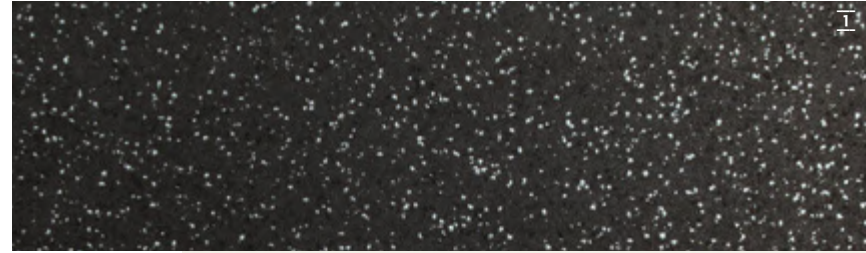

FABRICS INTERIOR

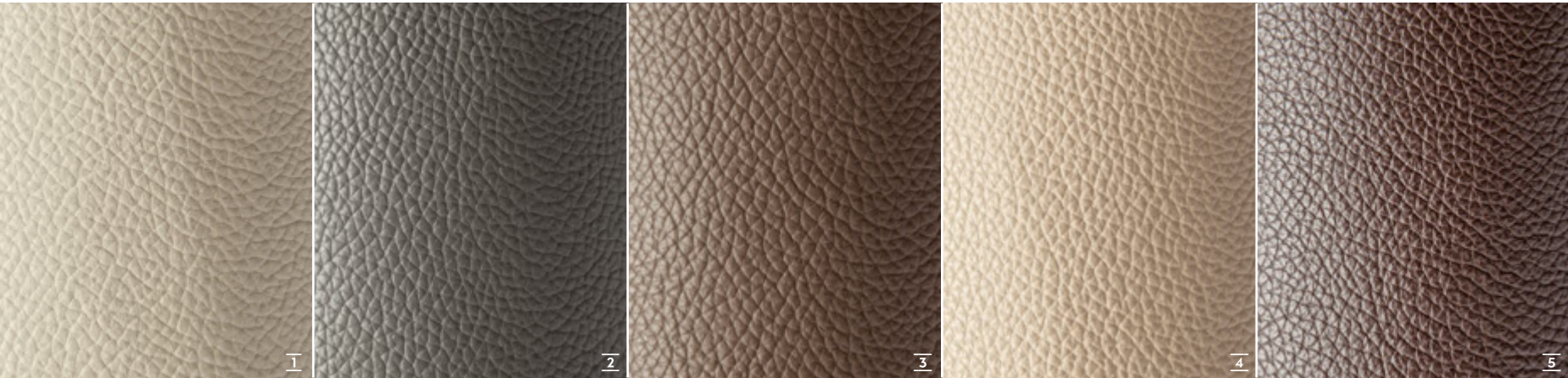

**PORTOFINO LEATHER**

Options: 1 Ivory 2 Basalt 3 Mud 4 Clay 5 Chocolate



**SORRENTO**

Options: 1 Taupe 2 Silver  
3 Stone 4 Charcoral 5 Denim







## MONTE CARLO

Standard: Cream



## MONACO

Options: 1 Almond 2 Bronze 3 Rock Island  
4 Black Truffle 5 Husky

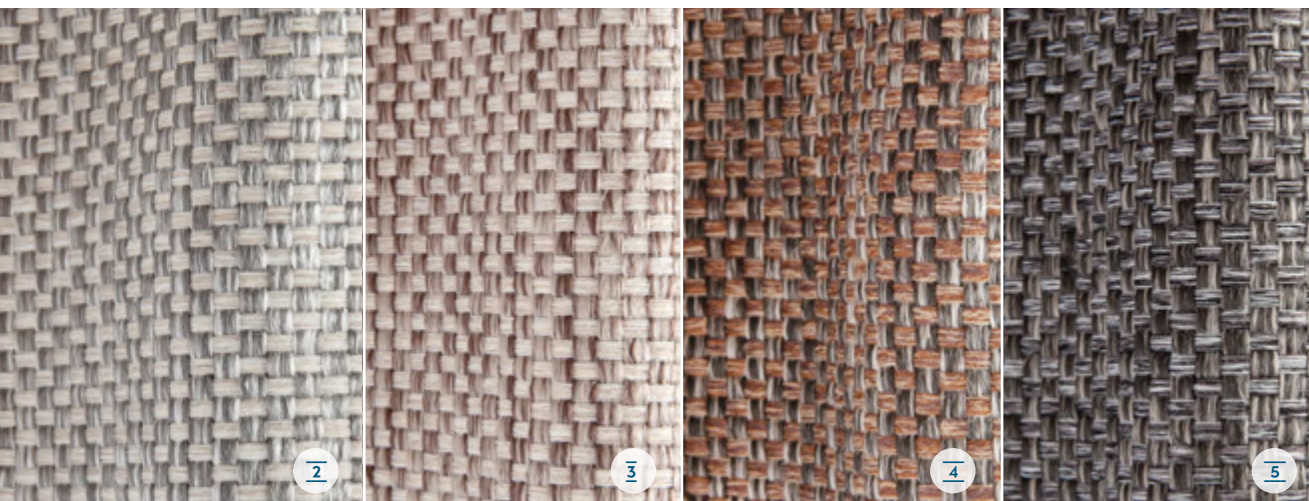

## FLORENCE

Options: 1 Cliffside 2 Glacier  
3 Oyster 4 Muscat 5 Graphite



1 Coast Gold 2 Red 3 Dark Blue 4 Ocean Blue 5 Black 6 Grey 7 Natural

And many more colours - it's your choice.

## GENNAKER

## HANSE CROSSOVER SAIL

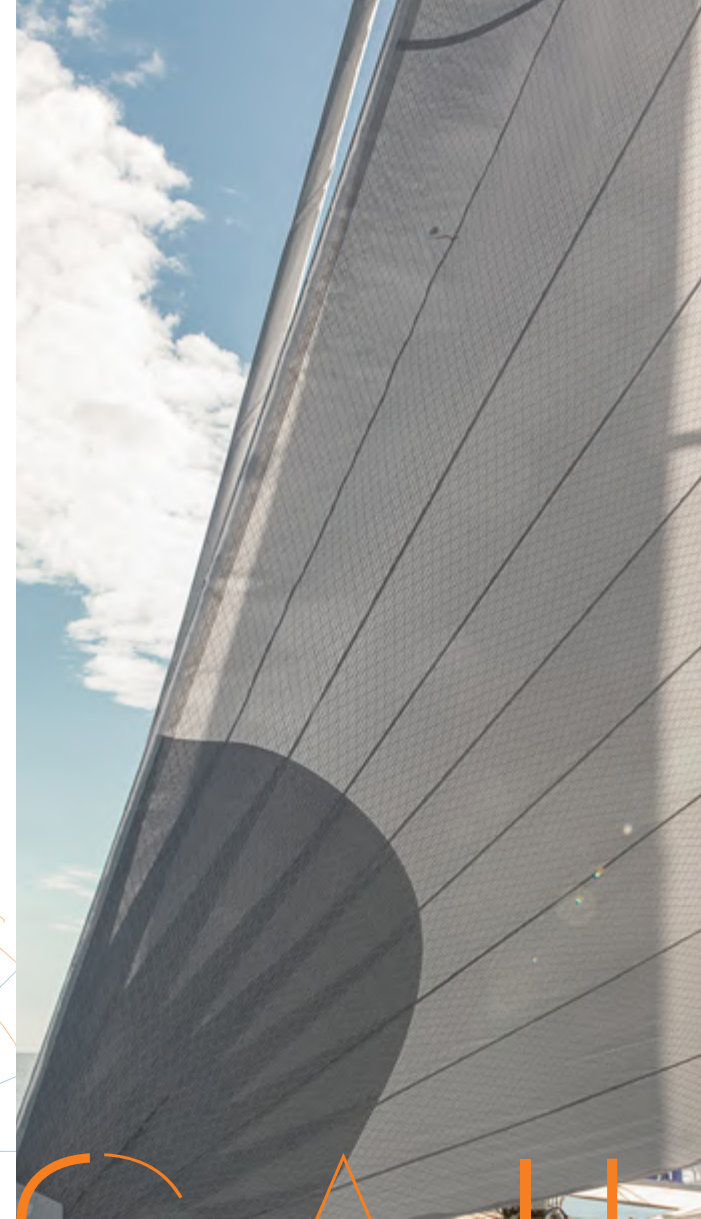
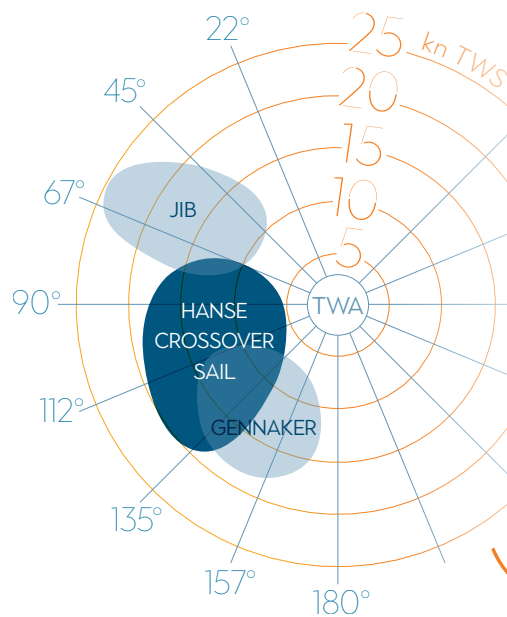

# SAIL CROSSOVER



## FAST CRUISING LAMINATE SAILS

- Höhere Formstabilität für bessere Segeleigenschaften
- Längere Lebensdauer für den ambitionierten Fahrtensegler
- Für HANSE Yachten exklusiv entwickelt von Jesper Bank

- Increased stability for high performance
- High durability for ambitious cruising
- Exclusive Design by Jesper Bank for HANSE yachts

DESIGNED BY JESPER BANK  
**FCL**

ELVSTRÖM FCL 5-LAYER PERFORMANCE TRIOPTIMAL SAILS

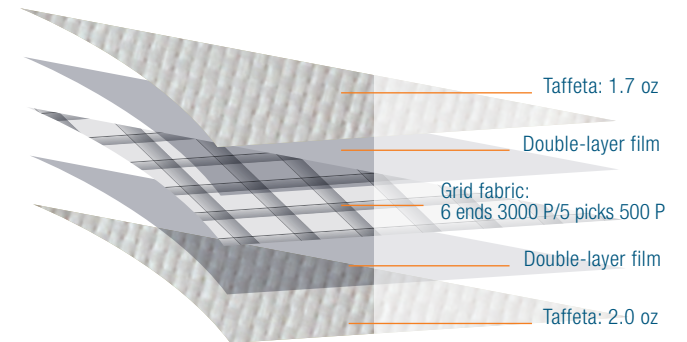

FAST  
CRUISING LAMINATE SAILS

PERFORMANCE SAILS



1 Coast Gold 2 Red 3 Dark Blue 4 Ocean Blue 5 Black 6 Grey 7 Natural

And many more colours - it's your choice.

**GENNAKER**

## HANSE CROSSOVER SAIL

- Segel Performance ab 5 Knoten Wind
- Segelfläche 38,60 m<sup>2</sup> (ca. 415 sq ft)
- Größtes Windrichtungsspektrum seiner Klasse
- Grüne Alternative zum Motor
- Idealer Zusatz zur Selbstwendefock
- Zweites Vorstag

- Sailing performance from 5 kn wind speed
- Sail area 38.60 m<sup>2</sup> (approx. 415 sq ft)
- Largest wind angle range in its class
- Green alternative to the engine
- Ideal complement to the self-tacking jib
- Additional forestay

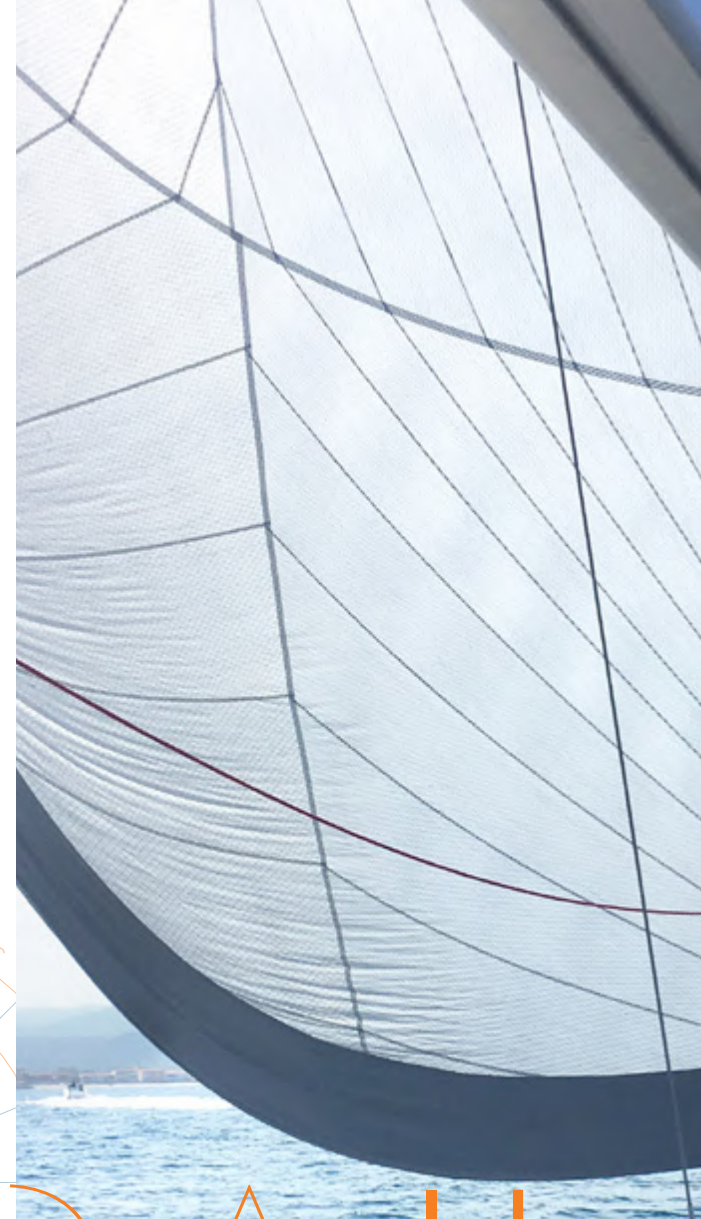
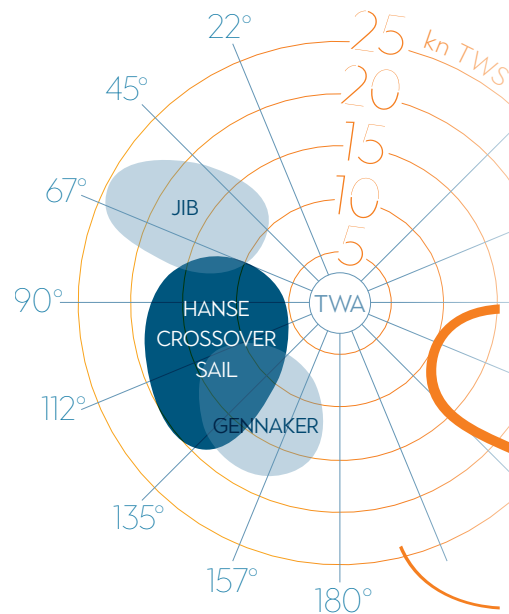

**CROSSOVER**

# TECHNOLOGY

Die Quantum iQ Technology® in Kombination mit präziser Handwerkskunst nach dem neuesten Stand der Technik machten die Entwicklung des Quantum Segels AC5 Active Cruising erst möglich. Die AC5 Segel wurden so designed, dass keiner Ihrer Wünsche an ein Segel offen bleibt: extrem vielseitig, langlebig und einfach zu bedienen. So meistern Sie alle Herausforderungen, die ein aktiver Segel-Lifestyle mit sich bringt.

The Quantum Sails AC5 Active Cruising sails were engineered using Quantum's iQ Technology® design process paired with precision craftsmanship using state-of-the-art materials and tools. The AC5 sails are designed to give you the experience you want, while also being extremely versatile, durable, and easy to use so that you can confidently face whatever challenges your active cruising lifestyles brings.

## MAIN SAIL DETAILS

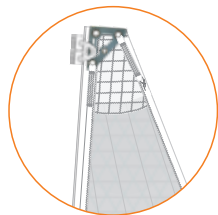

Head Corner Patch

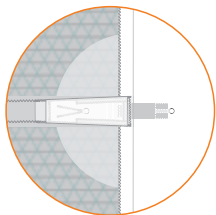

Batten Tensioning System

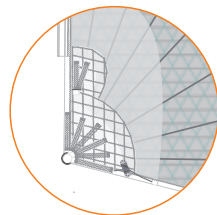

Tack Corner Patch

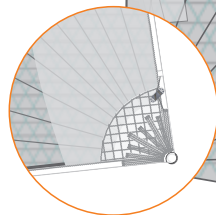

Clew Corner Patch

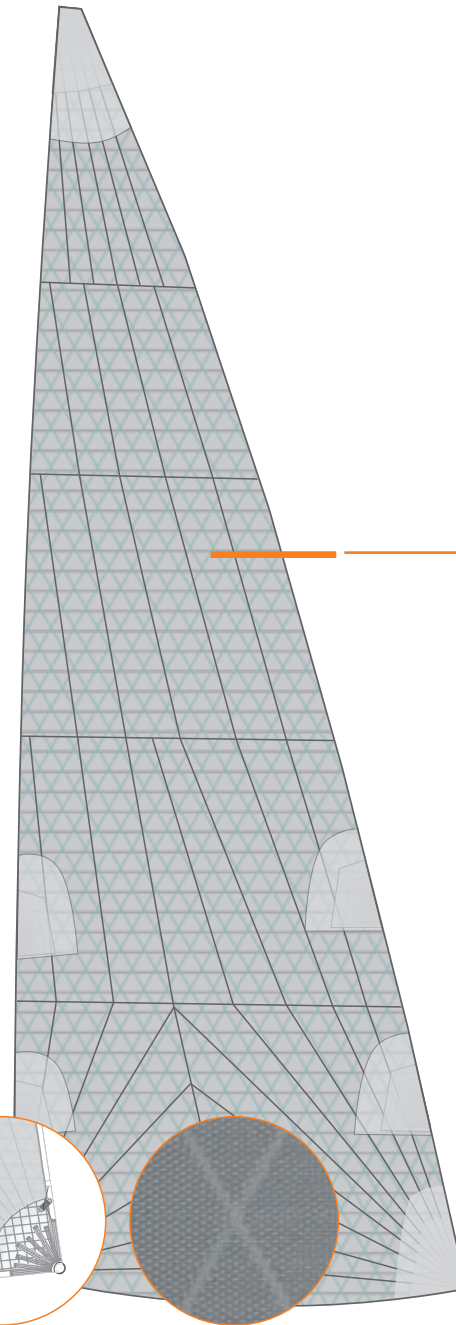

## ACTIVE CRUISING SAILS

- QUANTUM SAILS iQ TECHNOLOGY®
- Höhere Formstabilität für bessere Segeleigenschaften
- Längere Lebensdauer für den ambitionierten Fahrtensegler
- Für HANSE Yachten exklusiv designed von Quantum
- Custom panel design

- QUANTUM SAILS iQ TECHNOLOGY®
- Increased stability for high performance
- High durability for ambitious cruising
- Exclusive design by Quantum for HANSE yachts
- Custom panel design

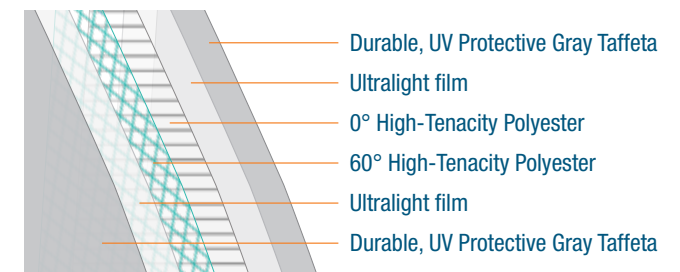

## PERFORMANCE SAILS

## NAVIGATION PACKAGE B&G



**B&G Vulcan 7" chart plotter**  
in cockpit or in instrument pod on coach roof



**2 B&G Triton<sup>2</sup> multifunction displays**  
in cockpit or on coach roof  
incl. transducer (wind/speed/depth/temperature)

## ENTERTAINMENT PACKAGE SALOON & COCKPIT



**FUSION MS-RA70N Multimedia radio**  
with Bluetooth® for saloon und cockpit  
**FUSION MS-BT100 Bluetooth® audio link**

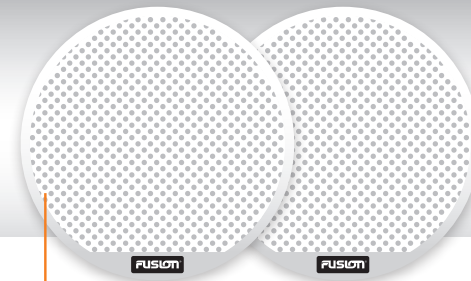

**2 high-end 2-way speakers**  
in saloon  
**2 high-end 2-way speakers**  
in cockpit  
- Shock resistant, watertight



**UPGRADE NAVIGATION PACKAGE**



**B&G VHF V60**  
at chart table,  
incl. wireless remote handset H60



**VHF preparation**  
with antenna and splitter for FM and AIS

**B&G Autopilot**  
with Triton<sup>2</sup> control unit  
and Precision 9 compass

**NAVIGATION & ENTERTAINMENT**

# XTRAS

MORE

315

Die Optionsvielfalt von HANSE gibt Ihnen mehr Freiheit – räumlich und gestalterisch. Hier finden Sie ausgesuchte Extras für Ihre HANSE 315.

The variety of individual options at HANSE gives you more freedom – spatially and artistically.



1 Seefeste elektrische Ankerwinch für müheloses Ankern 2 Schnell und einfach ausklappbare Badeplattform mit Teak und klappbarer Edelstahl-Badeleiter 3 Ein Traveller für die Großschot ermöglicht optimalen Trimm 4 Edles Teak oder strukturechtes Synthetik-Teak setzen optische Akzente auf dem Laufdeck und im Cockpit 5 Perfekt erreichbare LEWMAR 40 ST EVO Winschen zum einfachen Bedienen des Crossover Sails 6 Formschöne Carbonite Steuerräder im Y-Spoke-Design, wahlweise in Schwarz oder Weiß 7 Hochwertiger Cockpittisch aus hochwertigem Edelstahl und edlem Teak 8 Ein Lazy-Bag mit Lazy-Jacks in verschiedenen Farben lässt das Großsegel schnell verschwinden





1 Seaworthy, electric anchor winch for effortless anchoring 2 Fast and easily foldable bathing platform with teak and foldable stainless steel bathing ladder 3 A traveller for the large sheet enables optimal trimming 4 Elegant teak or genuine synthetic teak set aesthetic accents on the Sidewalk and in the cockpit 5 Perfectly accessible LEWMAR 40 ST EVO winches for easy operation of the crossover sails 6 Beautifully formed carbonite wheels with a Y-spoke design, in your choice of black or white 7 High-quality cockpit table made of premium stainless steel and elegant teak 8 A lazy bag with lazy jacks in different colours lets the big sail quickly disappear

**ORIGINAL ACCESSORIES**



MADE IN  
**GERMANY**  
SINCE 1990



Breaking rules, setting trends – für uns ist das mehr als ein kluger Satz. Es ist eine Haltung, die wir mit jedem neuen Boot Wirklichkeit werden lassen. Eine Haltung, die Sie auf jeder Seemeile fühlen, erleben und genießen werden – und über die Sie auf den nächsten Seiten mehr erfahren.

Breaking rules, setting trends. To us, this is more than just a catchphrase. It is a commitment we make a reality with each finished yacht. A commitment you can feel, experience and enjoy sea mile by sea mile. Discover more about this on the following pages.



# BREAKING RULES SETTING TRENDS

“ A blend of striking design, innovative features and very keen pricing has made this yard a real success story. ”

Sailing Today Magazine

Bis heute gewannen HANSE Yachten insgesamt mehr als 62 internationale Auszeichnungen.

To date, yachts made by HANSE have won more than 62 international awards.



6 OVER / ft

Jede fertiggestellte HANSE Yacht setzt Maßstäbe in technologischer Innovation, einfachem Handling und höchster Individualität. Das gilt bis in die höchste Bootsbau-Klasse

“ The HANSE 675 is a dream boat. Putting up the sails becomes a joyful experience: You can easily catch the wind and adjust to the wind strength. Mooring and anchoring



Bei berühmten Regatten feiern HANSE Yachten immer wieder große Erfolge, z.B. auf der Atlantic Rally for Cruisers, der Copa del Ray oder der Nordseewoche.

Time and time again, HANSE yachts achieve great successes in legendary regattas such as the Atlantic Rally for Cruisers, the Copa del Ray or the Nordseewoche.

“Only boats with outstanding performance characteristics deserve the name HANSE.”  
Dr Jens Gerhardt | CEO HANSE

HANSE entwirft seine Yachten in Zusammenarbeit mit den Weltklasse-Designern judel/vrolijk & co. Die erste gemeinsame Entwicklung wurde sofort zum Klassiker: die HANSE 371.

HANSE create their yachts in cooperation with world-renowned boat designers judel/vrolijk & co. Our first joint development became an instant classic: the HANSE 371.



“HANSE has a tireless passion for new ideas. It's a pleasure to work with them. And a challenge, too.”  
Rolf Vrolijk



In allen Erdteilen schwören Segelbegeisterte auf HANSE. Das Händlernetz der weltweit zweitgrößten Segelyachtwerft liefert in 70 Länder.

All over the world, sailing enthusiasts favour HANSE yachts. The international dealer network of the world's second-largest sailing yacht manufacturer delivers to 70 countries.

“At world's end, HANSE yachts are as highly coveted as in Germany.”  
Anthony Bishop | Dealer, Australia

über 60 Fuss. | Each manufactured HANSE yacht sets a new benchmark in technical innovation, easy handling and extreme individuality. This also holds for the largest class in sailboat building over 60 feet.

are also one button push away.” Philippe Fornier | HANSE 675 owner



HANSE steht für Innovationen, die einfach überraschen – und auf die man nie wieder verzichten will. Unser neuestes Beispiel: der E-MOTION RUDDER DRIVE der HANSE 315.

HANSE is best known for inventions that are surprising and indispensable at the same time. The latest example is the E-MOTION RUDDER DRIVE of the HANSE 315.

*“Yachts by HANSE are the real 21st century boats. They shape the present and show the way into the future.”*

Raoul Bajorat | Head of Development HANSE



*“You won't find any production yacht more customisable than a HANSE.”*

Maxim Neumann | Sales Director HANSE

Unsere Vielfalt an Polsterstoffen, Möbelhölzern oder Teppichen ergibt für den Eigner tausende Einrichtungsvarianten. Eine so große Auswahl ist einzigartig im Markt.

Thanks to the wide range of upholstery, furniture wood and carpets, we offer thousands of individual furnishing arrangements. A wide choice like this is unique in the market.





Bei HANSE arbeiten 890 segelbegeisterte Profis Hand in Hand. Unterstützt von modernsten Fertigungsprozessen. Getrieben von absoluter Hingabe zum Beruf.

At HANSE, 890 dedicated sailing enthusiasts work together hand in hand. Supported by cutting-edge production processes. Driven by total commitment to their profession.

“ We and our customers are kindred souls: There is nothing we enjoy more than a flawlessly engineered sailing yacht. ”

Pascal Kuhn | Product Marketing HANSE



Anfang der Neunziger revolutionierte die erste, je gebaute HANSE Yacht den Bootsmarkt: Sie wurde als erstes Serienboot mit integrierter Selbstwendefock ausgestattet.

In the early 1990s, the very first HANSE started a revolution in boat building. It featured the first integrated self-tracking jib ever produced in series.

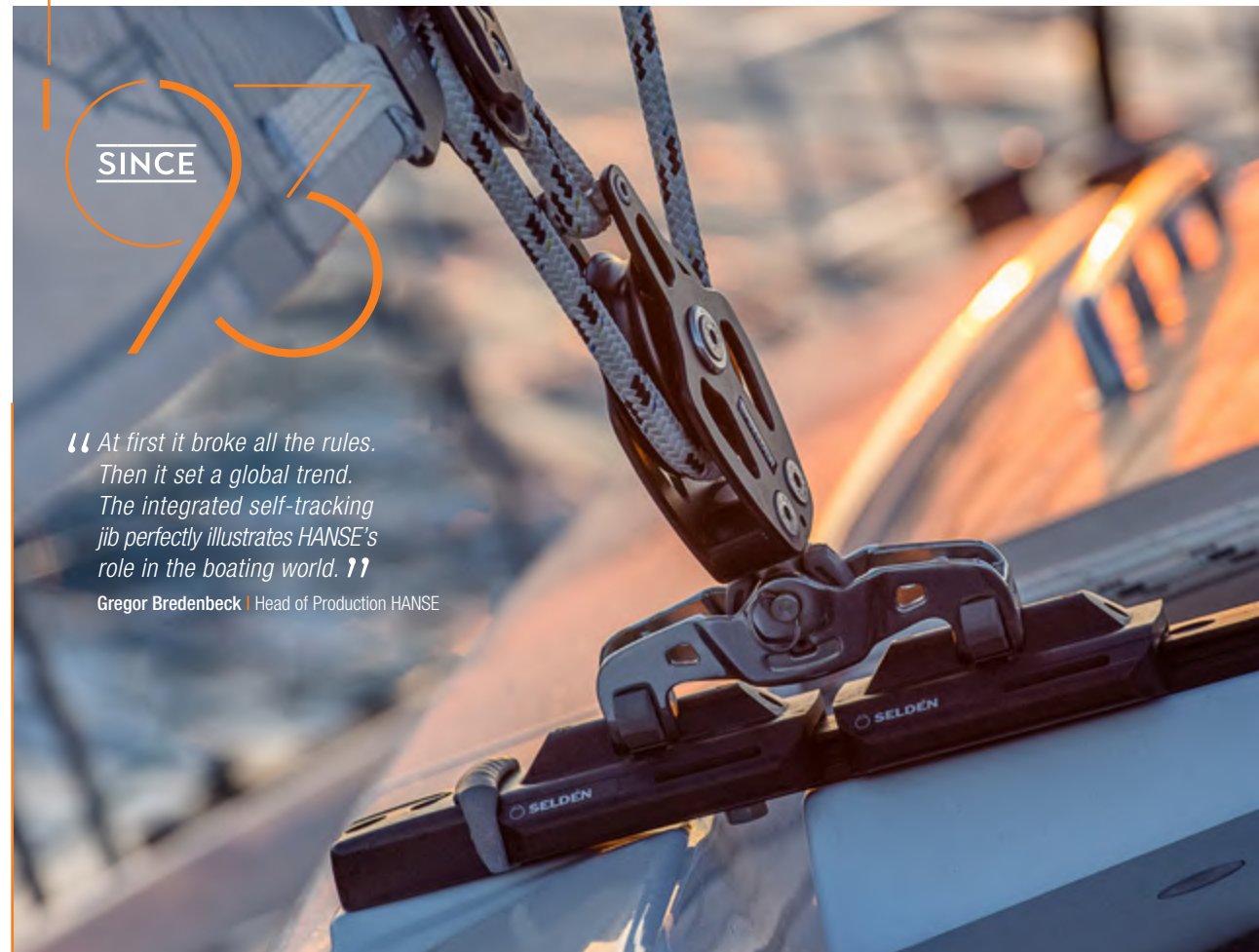

SINCE

“ At first it broke all the rules. Then it set a global trend. The integrated self-tracking jib perfectly illustrates HANSE’s role in the boating world. ”

Gregor Bredenbeck | Head of Production HANSE

HANSE YACHTS



Beeindruckend in jedem Detail, überwältigend als Gesamtwerk: HANSE Yachten sind weit mehr als die perfekt abgestimmte Verbindung von Design und modernsten Technologien. Sie repräsentieren die Erfahrung und das Wissen der HANSE Ingenieure. Ihre Leidenschaft zum Yachtsport lassen sie in unvergleichlicher Präzision und Akribie in jeder HANSE Wirklichkeit werden.

Impressive in every detail, HANSE yachts are masterpieces made to take your breath away. They are far more than a perfectly harmonised ensemble of design and the most modern technologies. They reflect the experience and know-how of HANSE engineers. Their passion for yachting can be felt in the unmistakable precision and meticulous detailing found in every HANSE.

HANSE  
ENGINEERING

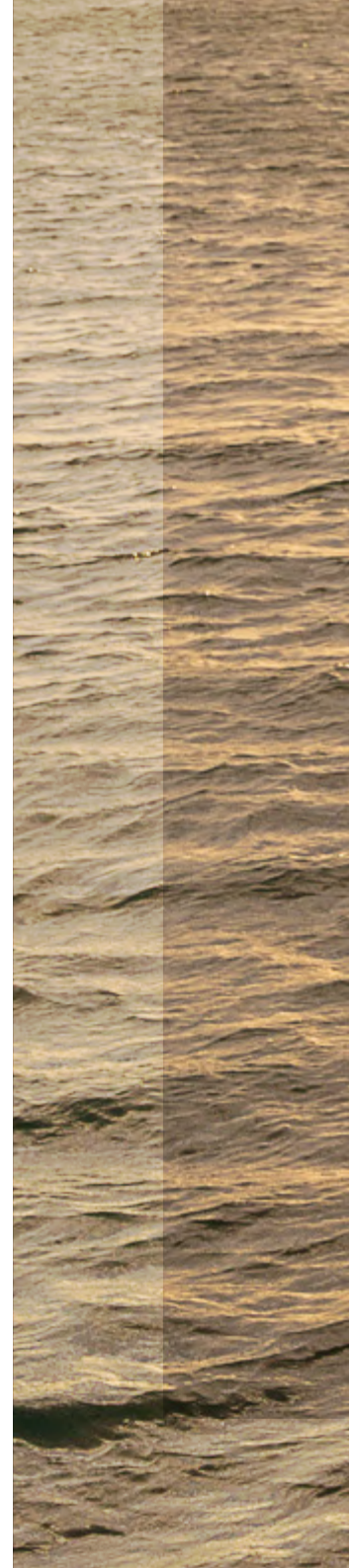







### BOAT MONITOR\*

#### FRIDGE

Turn on/off remotely

#### LIGHTS

Turn on/off

#### HATCH/DOOR SENSOR

Monitor unauthorized access

#### SHORE POWER

Monitor connection

#### ENGINE

Monitor activity

#### MOTION SENSOR

Collision and grounding detection

#### FUEL TANK

Monitor level

#### WATER TANK

Monitor level

#### BATTERY BANK

Monitor level

#### GPS, WIND AND SPEED DATA

#### ANCHOR WINCH

Monitor activity

#### BOW THRUSTER

Monitor activity

#### BILGE PUMP

Monitor activity

\*Steuerung und Sensoren sind abhängig von der Konfiguration Ihrer HANSE. / Controlling and sensors depend on the configuration of your HANSE.

# MY HANSE SAFETY CLOUD

Alles unter Kontrolle. Mit der MyHanse Safety Cloud haben Sie vollen Zugriff auf alle wichtigen Daten Ihrer HANSE. Jederzeit und von jedem Ort aus. Intelligente Anwendungen wie BoatMonitoring, eLogBook und eServiceBook ermöglichen es Ihnen, Ihre Yacht unkompliziert und bequem zu überwachen, automatisch Logbuch zu führen und sämtliche Wartungstermine stets im Blick zu behalten.

Everything under control. With the MyHanse Safety Cloud you gain full access to all important data of your HANSE. At any time and any place. Intelligent applications as BoatMonitoring, eLogBook and eServiceBook allow you to supervise your yacht easily and comfortably, to keep the logbook automatically up to date and to keep an eye on all maintenance dates.



## MANUALS

Alle Handbücher und Anleitungen in einer App.

All manuals and instructions within one app.

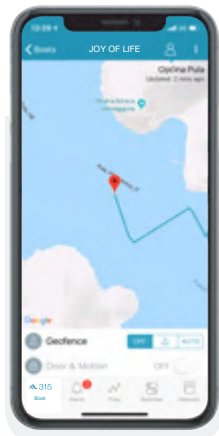

## POSITION

Verfolgen Sie Ihre Position in Echtzeit.

Track your position in real-time.

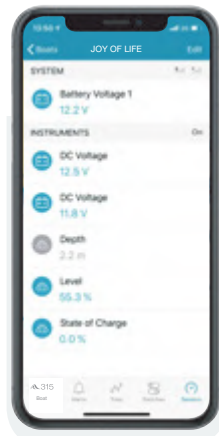

## SENSORS

Überwachen Sie Ladestände und Geräte.

Monitor your charge levels and devices.

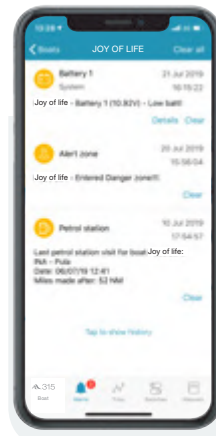

## ALARMS

Push-Nachrichten bei aktuellen Ereignissen.

Push notifications on current events.

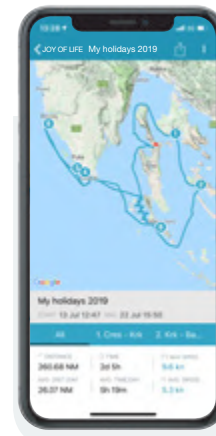

## TRIP LOG

Teilen Sie Ihre geloggtten Törns mit Freunden.

Share your cruises and track data with friends.

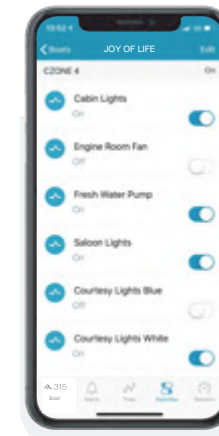

## CONTROL

Bedienung elektronischer Geräte per Fernsteuerung.

Operate your electronic devices by remote control.

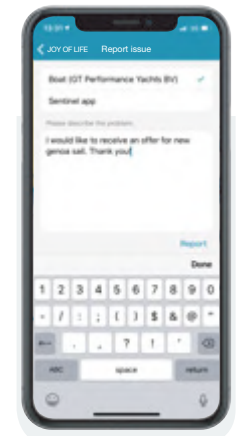

## LIFE REPORT

Direkter Händler Kontakt für schnelle Hilfe.

Direct contact to your dealer for quick help.



## KEEL HULL CONNECTION

Safety first. Die Kielplatten liegen sicher in einem ultrafesten Bett aus Epoxidharzkleber. Dadurch ist der Kiel direkt in der mächtigen Bodenstruktur verankert. Die Kiel-Bolzen inklusive Scheiben und Muttern sind aus Edelstahl gefertigt.

Safety first. The keel plates lie securely in an ultra-strong bed made of epoxy resin. This means that the keel is directly anchored in the powerful floor structure. The keel bolts, including discs and nuts, are made of stainless steel.

## BULWARK

Für das gute Gefühl auf See: Die extrahohe Fußbreitung von HANSE. Sie vereint die dynamischen Rumpflinien elegant mit dem hohen Seezaun und sorgt so für ein Maximum an Sicherheit.

For your good feeling at sea: the extra-high bulwark from HANSE. It elegantly combines the dynamic hull lines with the high railing and thus ensures a maximum of safety.





## HULL-DECK CONNECTION

In Zusammenarbeit mit judel/vroljik & co hat HANSE eine spezielle Deck-Rumpf-Verbindung entwickelt, die deutlich über den allgemeinen Anforderungen liegt. Neben dem Einsatz von hochfestem Polyesterklebharz, werden Deck und Rumpf mithilfe von Bolzen in den Klampen zusätzlich verankert und ergeben eine steife, torsionsfreie Yacht mit sportlichem Charakter.

In collaboration with judel/vroljik & co, HANSE has developed a special hull-deck connection which goes well beyond all standard requirements. In addition to the use of highly robust polyester bonding resin, the deck and hull are anchored with the use of high-strength bolts in the cleats. This results in a stable, torsion-free yacht with a sporty character.

## SANDWICH CONSTRUCTION

Die HANSE 315 wird im hochwertigen Sandwichverfahren gebaut. Der Rumpf besteht aus mehreren Schichten ausgewählter Materialien und ist bis ins Detail genau berechnet. Er ist dadurch besonders leicht und dank der äußeren Vinylester-Laminatschicht vollkommen resistent gegen Osmose.

The HANSE 315 is constructed using the high-quality sandwich process. The hull features several layers of select materials and is precisely calculated in every detail. It is particularly lightweight and, thanks to the exterior vinylester layer, completely resistant to osmosis.

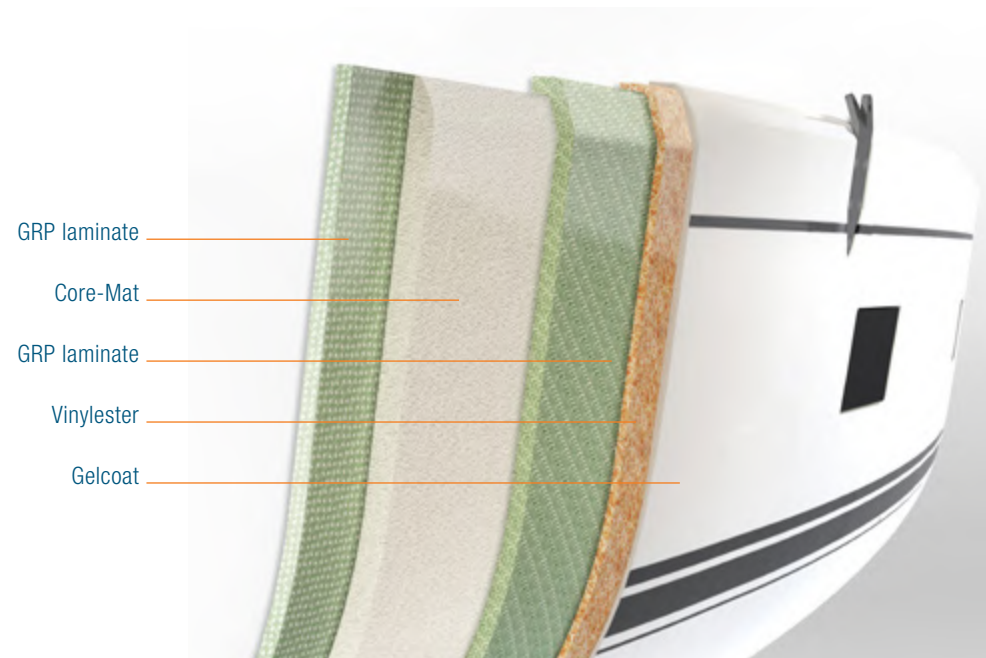

# E-MOTION

HANSE RUDDER DRIVE



## THE REVOLUTION IN YACHTING

Mit dem HANSE E-MOTION RUDDER DRIVE – einem weltweit revolutionären Antrieb – setzt HANSE wieder neue Maßstäbe. Ein fest in das Ruderblatt eingearbeiteter Elektromotor inkl. Propeller ersetzt den Dieselmotor mit Saildrive. Das Ergebnis: Die Yacht wird aktiv gesteuert, da die Schubkräfte des Propellers direkt in die Richtung der Ruderstellung gelenkt werden. Das ermöglicht Ihnen kleinste Wendekreise oder das Drehen um den eigenen Kiel – perfekt für Manöver in engen Häfen.

Introducing the HANSE E-MOTION RUDDER DRIVE – a groundbreaking propulsion type – HANSE once again sets new standards. An electric engine and a folding propeller have been installed into the rudder shaft, replacing the combination of diesel engine and sail drive. As a result, the propeller thrust is perfectly in line with the rudder position. This enables turning in the smallest circles or rotating around your own keel – a perfect solution for manoeuvring in narrow ports.



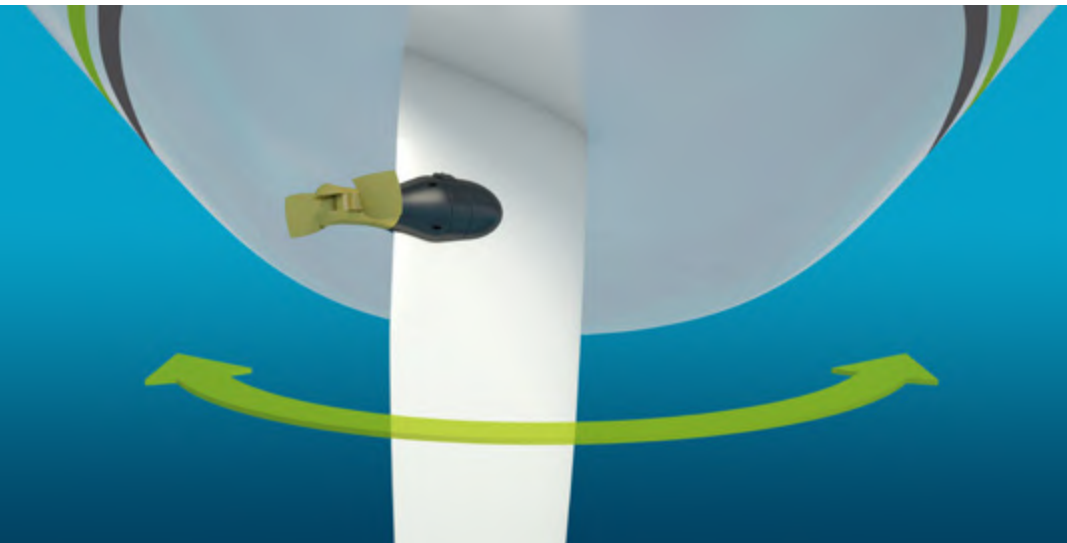

## *e*motion RUDDER DRIVE

- Ideale Manövrierfähigkeit: dank aktiver, direkter Lenkung
- Sauberer, leiser Antrieb: mit 4 kW starkem Motor, 6,1 kn Top Speed und 30 sm Reichweite bei 4,5 kn
- Kein Tanken nötig: die Batterien sind in 3 h am Liegeplatz wieder voll aufgeladen
- Kaum Wartung: vergessen Sie Ölwechsel, Ölstandskontrolle, Überprüfung des Impellers und der Filter
- Weniger Borddurchlässe: Saildrive und Auspuff entfallen
- Deutlich leichter: das heißt mehr Performance und Spaß beim Segeln
- Zusätzliche Kontrolle per App: Batteriestand, Position, Reichweite, Speed und Tracking

- 
- Perfectly manoeuvrable: due to active, direct steering
  - Clean and quiet drive: with 4 kW engine power, 6.1 kn top speed and 30 nm range at 4.5 kn
  - No fuel required: recharging the batteries at the berth will take 3 hours
  - Virtually no maintenance: forget about changing oil or checking the oil level, impellers and filters
  - Less outboard outlets: because there is no saildrive or exhaust
  - Significantly less weight: more performance, more sailing fun
  - Additional control via app: battery status, position, range, speed and tracking



# 315

---

SPECIFICATIONS





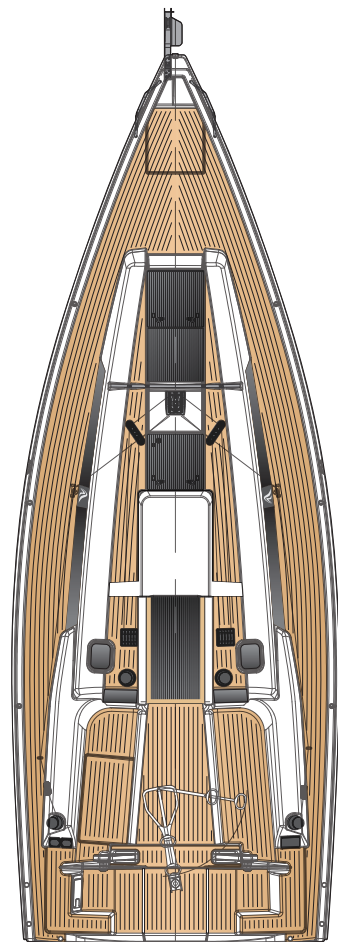

Beam 3.35 m | 11'



LOA 9.62 m | 31'7"

LOA	9.62 m	31'7"
Hull length	9.10 m	29'10"
LWL	8.70 m	28'7"
Beam	3.35 m	11"
Draft		
L-keel, shallow	1.35 m	4'5"
L-keel, medium	1.85 m	6'1"

Displacement			
L-keel, shallow	approx.	5.30 t	11,684 lbs
L-keel, medium	approx.	5.10 t	11,243 lbs

Engine – Diesel			
standard	approx.	13.6 PS	13.6 HP
option	approx.	21.0 PS	21.0 HP
Fuel tank	approx.	100 l	26 gal
Fresh water	approx.	210 l	55 gal
CE Certificate	B - 7		
Design	judel/vrolijk & co		
Interior	HanseYachts Design		

Mast length above WL	approx.	14.35 m	47'1"
Total sail area	approx.	47.00 m <sup>2</sup>	506 sq ft
Main sail	approx.	29.50 m <sup>2</sup>	818 sq ft
Self-tacking jib	approx.	17.50 m <sup>2</sup>	188 sq ft
Genoa	approx.	21.50 m <sup>2</sup>	231 sq ft
Gennaker	approx.	68.50 m <sup>2</sup>	737 sq ft
CrossOver	approx.	38.60 m <sup>2</sup>	415 sq ft
Rig			
I		22.40 m	73'6"
J		6.44 m	21'2"
P		21.80 m	71'6"
E		7.10 m	23'4"

All measurements are approximate. Specifications and material can change without notice. Errors excepted.



This brochure is not contractual. The yachts depicted partly comprise special equipment not included in the standard scope of supply. Illustrations may not correspond with current versions. Subject to alterations in design and equipment without notice and errors excepted. Photos/Illustrations: HanseYachts, Nico Krauss, Michael Amme, Peter-Paul Reinmuth, Jule/Vrolijk & Co, Malwin Faber, Shutterstock | Design: design-harksen.de & ulfson.de | Print: Druckhaus Panzig

CIB315/H0920